

Putting the Community First

BARNET
LONDON BOROUGH



**GRAHAME PARK
SUPPLEMENTARY PLANNING DOCUMENT**

MAY 2016

LONDON BOROUGH OF BARNET

PLANNING AND COMPULSORY PURCHASE ACT 2004 TOWN AND COUNTRY PLANNING (LOCAL PLANNING) (ENGLAND) REGULATIONS 2012

GRAHAME PARK SUPPLEMENTARY PLANNING DOCUMENT

Director of Regeneration and Strategic Planning, London Borough of Barnet,
Barnet House, 1255 High Road, Whetstone, N20 0EJ.

CONTENTS

1.0				
INTRODUCTION	5	4.0	DESIGN GUIDELINES	41
1.1		4.1		
STRUCTURE	8	SITE-WIDE OPEN SPACE STRATEGY		44
1.2		4.2		
SPD TIMETABLE AND SUPPORTING DOCUMENTATION	8	SITE-WIDE STREETScape - A BARNET CODE FOR PUBLIC REALM		46
		4.3		
2.0		SITE-WIDE URBAN DESIGN STRATEGY		48
BACKGROUND AND OBJECTIVES	11	4.4		
2.1		SITE-WIDE HOUSING PRINCIPLES		50
THE CONTEXT	13	4.5		
2.2		SITE-WIDE SUSTAINABILITY & ENVIRONMENTAL AIMS		52
THE AREA TODAY	15	4.6		
2.3		SOUTHERN CHARACTER AREA		54
THE VISION FOR GRAHAME PARK	18	4.7		
		NORTHERN CHARACTER AREA		68
3.0		4.8		
DEVELOPMENT FRAMEWORK	23	CENTRAL CHARACTER AREA		82
3.1		4.9		
CORE DESIGN PRINCIPLES	25	ST AUGUSTINE'S CHURCH SITE		96
3.2		4.10		
LAND USE MIX	26	ENERGY CENTRE		97
3.3				
OPEN SPACES & PLAY PROVISION	28			
3.4		5.0	DELIVERY	99
TREE STRATEGY & REAR GARDEN CONDITIONS	30	5.1		
3.5		PROCESS AND PHASING		101
STREET HIERARCHY	32	5.2		
3.6		THE PROPOSED PHASES		102
CAR PARKING	34	5.3		
3.7		CONSIDERATIONS		103
BUILDING HEIGHTS & DENSITY	36	5.4		
3.8		VIABILITY		104
RESIDENTIAL TYPOLOGIES	38			
		6.0	IMAGE CREDITS	108

1.0 INTRODUCTION

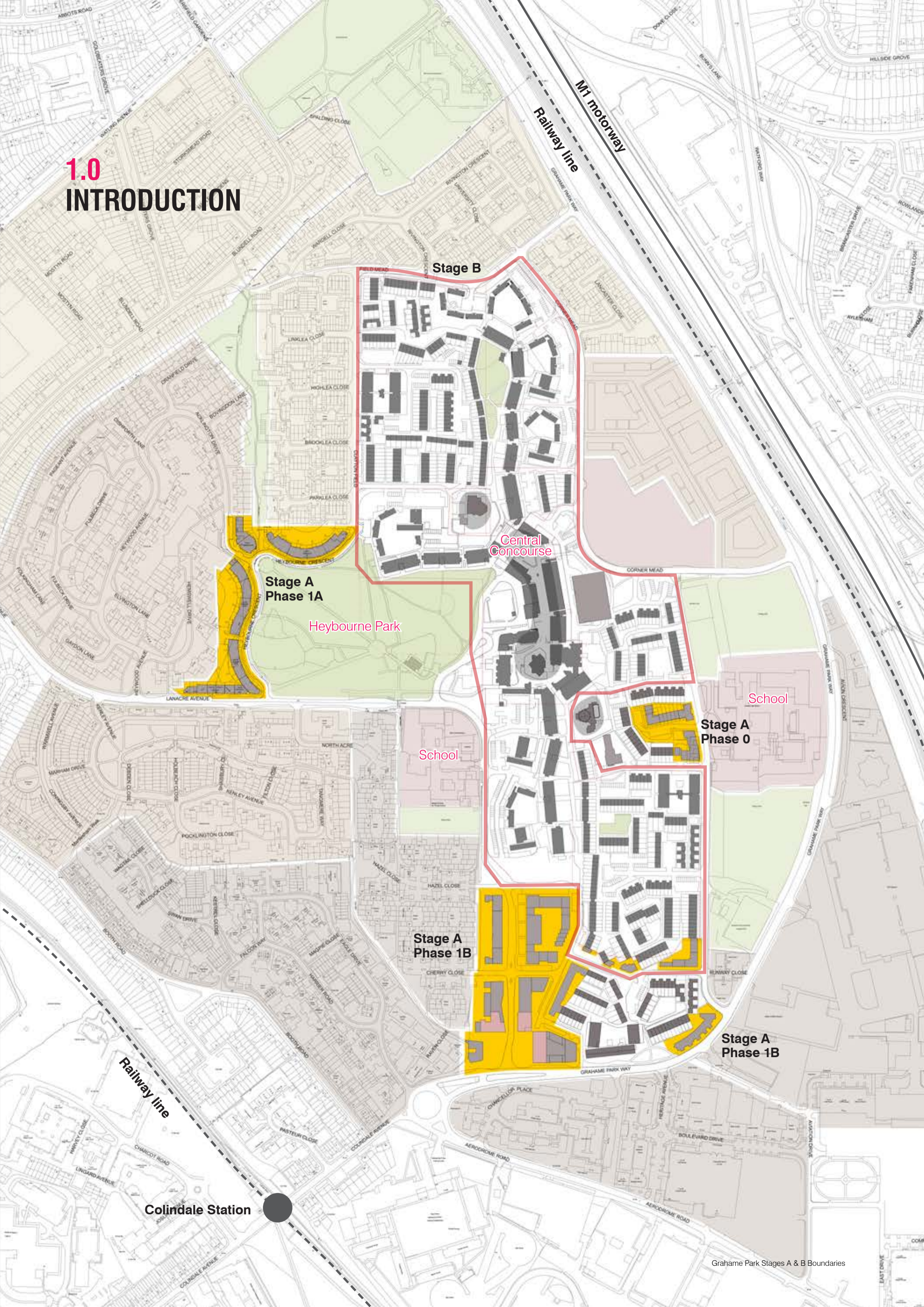

1.0

INTRODUCTION

This document is a Supplementary Planning Document (hereafter referred to as SPD), providing supplementary detail to policies contained within the London Borough of Barnet's (hereafter referred to as 'LBB' or the Council) Core Strategy (2012), Development Management Policies (2012) and Colindale Area Action Plan (2010). It also provides supplementary detail to the Mayor of London's London Plan (2015) in the form of Supplementary Planning Guidance (hereafter referred to as SPG).

This SPD should be read in conjunction with the Mayor's London Plan, LBB's adopted policies and other relevant Development Plan Documents and SPDs.

Formal Status of this Document

This SPD is a material consideration for the determination of any planning applications submitted within the Grahame Park Estate.

i. This SPD has been prepared in accordance with the National Planning Policy Framework, the Town and Country Planning (Local Development) (England) Regulations 2004 (as amended), the Town and Country Planning (Local Planning) (England) Regulations 2012, the Planning and Compulsory Purchase Act 2004 (as amended), and the Greater London Authority Acts 1999 and 2007.

ii. This document is supported by:

- a Sustainability Appraisal;
- an Equality Impact Assessment; and,
- the Initial Consultation Report.

Purpose of this document

iii. This document has been produced by Re (Regional Enterprise) Ltd on behalf of LBB. The overall objectives of this SPD are to:

- establish and provide guidance for Master planning within the site;
- establish detailed guidance on the application of policies within the London Plan and LBB's Development Plan Documents (DPDs) that will be used to assess any planning applications submitted in respect of land within the site;
- explain how the development will deliver the required infrastructure and socioeconomic benefits to support the new neighbourhood in this part of Colindale;
- engage all interested stakeholders in the development process.

iv. Grahame Park is identified in the London Plan (policy 2.14) as an 'Area for Regeneration'. Colindale/Burnt Oak is also identified as an Opportunity Area in the London Plan, with Annex 1 describing the area as "an area comprising a range of sites with capacity mainly for residential led mixed use".

v. Barnet Council own the majority of the site and have a development agreement with Genesis Housing Association (hereafter referred to as 'GHA') for the regeneration of the estate. LBB are actively collaborating with other landowners on the site to include their land within the wider redevelopment

proposals, such as the Anglican Church, who own the freehold for St Augustine's Church.

vi. Most of the first portion of the regeneration (Stage A) has either been constructed on site, has commenced or has been committed to by GHA, pursuant to the original outline consent granted in 2007 (hereafter referred to as 'the 2007 permission'). The main purpose of this document will therefore be to provide detailed guidance for Stage B of the development, but given the comprehensive nature of the scheme, this SPD will be a material consideration for all applications submitted in respect of land within the site. However, the Development Framework contained in Section 3 will only apply to Stage B of the development.

vii. It is recognised that flexibility will be needed to achieve the Council's strategic vision of the regeneration of Grahame Park Estate, as reflected in section 2 of this document. This SPD is not intended to preclude or constrain other acceptable development and/or strategies for achieving sustainable comprehensive regeneration in accordance with relevant London Plan and Core Strategy/Development Management Policies. The SPD has been drafted with this in mind, such that it can be applied to any application coming forward on the site and can be given appropriate weight in the decision making process, should national, regional or local policy change over the course of the development.

Policy content and Relationship to the Colindale Area Action Plan

viii. The site falls within the Colindale/Burnt Oak Opportunity Area, as identified in the London Plan. In addition, LBB's Core Strategy contains policies which relate to development in the Opportunity Area, as well as Grahame Park Estate more specifically. These policies require a minimum of 12,500 new homes and 2,000 jobs across all the sites in the area, as well as co-ordination of adequate provision of social and transport infrastructure.

ix. In 2010, LBB adopted the Colindale Area Action Plan (CAAP), which sets out the framework for development and change in the Colindale area. This SPD will sit below the CAAP and the guidance herein will provide supplementary detail to the policies contained in the CAAP. As well as the theme based policies in the CAAP that apply to any development in the opportunity area, there are specific policies that support the ongoing regeneration of Grahame Park Estate and set out specific objectives for the site. This SPD will support these objectives and will provide specific guidance for how these will be achieved.

x. In addition to these policies that are specific to the site and Opportunity Area, there are also theme based national, regional and local planning policies that apply to any development of the site. The Mayor of London and LBB have other theme based Supplementary Planning Guidance/Documents, which also apply to the redevelopment of the site.

1.1 STRUCTURE

Other than the Introduction (1.0), this SPD comprises the following sections:

Section 2: Background and Objectives

i. This provides background information about the site, the surrounding area and the ongoing regeneration programme. This section culminates in LBB's vision for the future of Grahame Park, which is the rationale for the guidance set out in the Development Framework.

Section 3: Development Framework

ii. A set of parameter plans that establish the key principles that new development should adhere to, including where land uses will be situated, where streets and development plots will be located, the scale of buildings and the size and location of open spaces. This section will culminate in an illustrative Masterplan showing how development could come forward in accordance with the parameter plans.

Section 4: Design Guidelines

iii. A set of guidelines that set out LBB's expectations for the detailed aspects of the development, including the types of housing, privacy and outlook standards, amenity space provision and the quality of architecture and public realm.

Section 5: Delivery

iv. An explanation of how the Council expects the development to come forward and what will be required when planning applications are considered. This will include provisions for phasing, community engagement, affordable housing and planning obligations, as well as any technical work that will need to be carried out.

v. Each part of the Development Framework has regard to the existing policy context, background information, character and appearance of the site and surrounding area and the results of consultation. Redevelopment of the site will be expected to meet the relevant objectives of all three sub-sections of the Development Framework.

1.2 SUPPORTING DOCUMENTATION

A number of supporting documents have been produced in order to inform this SPD and these can be found on LBB's website. A summary of each document is provided below:

Sustainability Appraisal

i. Assesses the potential impacts of the SPD on a range of environmental, social and economic criteria and includes a Strategic Environmental Assessment.

Equality Impact Assessment

ii. The EqIA assesses the SPD in the context of the prevention of discrimination against people who are categorised as being disadvantaged or vulnerable within society.

Statement of Consultation

iii. A statement setting out those consulted by LBB in connection with the preparation of the SPD, how the consultations were carried out, a summary of the main issues raised in those consultations and how the representations have been addressed in the SPD.

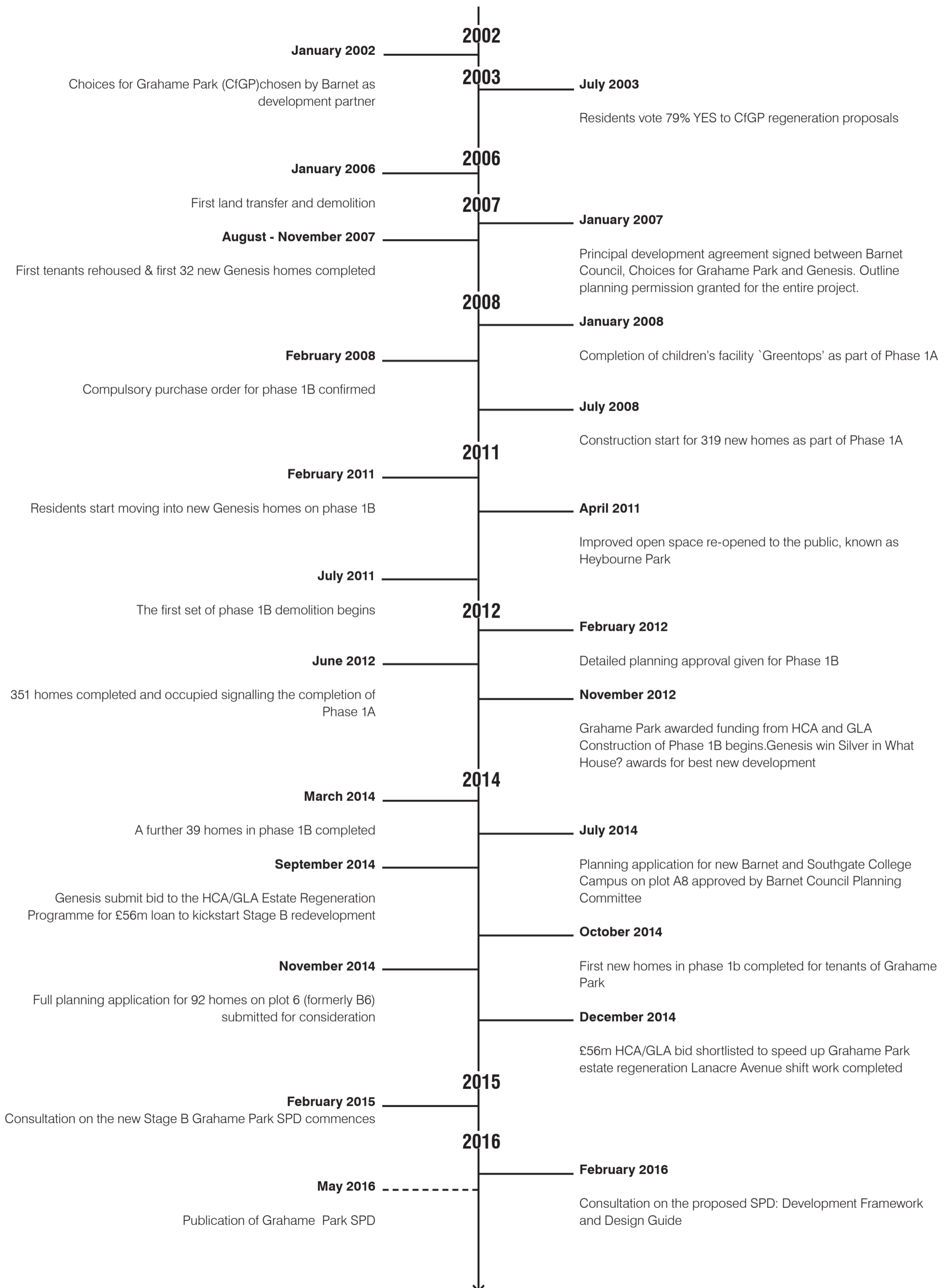

2.0 BACKGROUND AND OBJECTIVES



2.0

BACKGROUND AND OBJECTIVES

This section gives a broad overview of the physical, economic, social and environmental circumstances of the site and wider area, as well as the site history and the history of Colindale more widely. It will provide the background information to support the vision and objectives of this SPD.

There are three main sub-sections in this section:

- 2.1 The Context:

will describe the strategic context, the history of the site and surrounding area;

- 2.2 The Area Today:

will set out the main physical, economic, social and environmental factors that will influence the development of the site; and

- 2.3 The Vision for Grahame Park:

will outline LBB's vision for the new Grahame Park.

This vision has regard to the outcome of consultation and will directly influence the Development Framework set out in Section 3 of the SPD.

2.1 THE CONTEXT

Site and surrounding area

- i. The Grahame Park SPD Area is generally bounded to the west by Lanacre Avenue, to the south by Grahame Park Way, to the east by Great Strand and Corner Mead and to the north by Field Mead. It is located entirely within the Colindale ward of the Borough.
- ii. Grahame Park lies within the 'London-Luton-Bedford' corridor, a nationally recognised growth area of city region importance that the Mayor of London considers will benefit from the coordination of planning and investment. Colindale is expected to play an important role in this growth corridor, given its location between the strategic road network routes of the A5 and M1, as well as the Thameslink railway. The Brent Cross-Cricklewood Opportunity Area, to the south, and the Mill Hill East Intensification Area, to the east, are also both expected to undergo significant regeneration over the next 15-20 years.

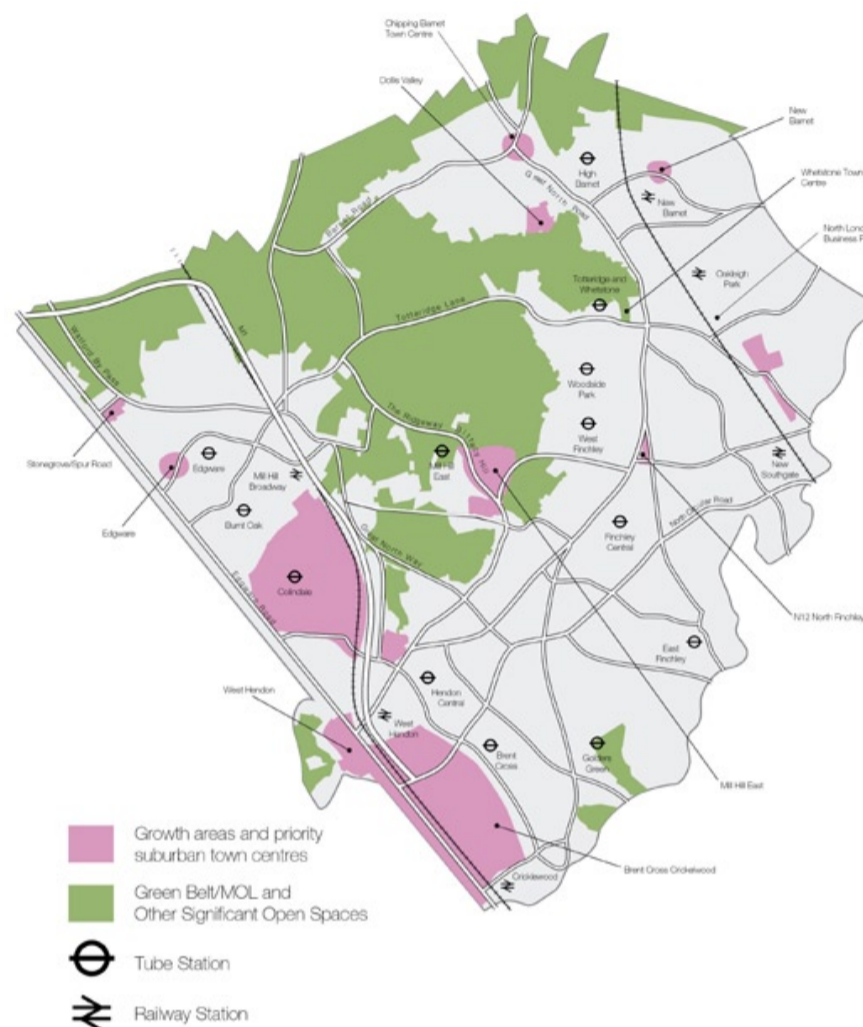

The London Borough of Barnet's Strategic Developments in The Three Strands Approach

Strategic Context

- iii. The site falls within the Colindale/Burnt Oak Opportunity Area, as identified in the London Plan. The Opportunity Area (OA) totals 262 hectares and comprises a range of sites mainly for residential-led mixed use, which are at various stages in the development process. The London Plan identifies the Opportunity Area as having capacity to deliver a minimum of 12,500 homes and 2,000 jobs, along with improvements to social and transport infrastructure.
- iv. LBB adopted the Colindale Area Action Plan (CAAP) in March 2010. This document sets out the framework for future development and change in the Colindale Area. Outline planning permission for the regeneration of Grahame Park had already been granted prior to the 2010 adoption of this document, so it was not the intention of the CAAP to directly influence the redevelopment of the site. However, it does contain area specific policies which do however lend support to the on-going regeneration of the estate, the replacement of its neighbourhood centre and its integration with surrounding areas.



The Colindale AAP area (highlighted by the red line)

Description and history of site and surrounding area

v. Grahame Park is the borough's largest housing estate, originally comprising 1,777 units of mostly social rented accommodation, along with a small neighbourhood shopping centre and various community facilities. The estate suffers from a number of socio-economic and physical problems. A tenants participation survey in 1999 identified a number of issues including the poor physical environment and poor image, unsafe and difficult circulation routes owing to the Radburn style separation of vehicles and pedestrians, overcrowding and inappropriate occupancy for large families, a high turnover of stock, poorly placed and poorly integrated local facilities and poor levels of shopping choice.

vi. In 2003 residents voted in favour of a full regeneration of the estate and in 2004 a new Masterplan secured outline consent for the whole site. However, the Masterplan is now 10 years old and out of date with only a small amount of the envisaged regeneration implemented. Since its production, significant private development has taken place on a number of other sites within the immediate area, which has not only affected the viability of Grahame Park, but also threatens to leave it isolated.

vii. GHA and the Council have therefore undertaken a review of the remaining part of the Masterplan for the regeneration of the Grahame Park estate, known as Stage B. The decision has been taken to undertake a comprehensive reappraisal of the site to address various issues, primarily viability but also other issues of product, sales and context within the wider Colindale Opportunity Area A where large quantities of private apartments for sale are being developed.

viii. The Grahame Park estate itself comprises a mixture of flats and houses, in buildings of varying heights and set in areas of open space. The central area, known as the Concourse, comprises mainly 5-7 storey apartment blocks and also contains almost all of the retail and community facilities. 4 and 5 storey apartment blocks extend to the north and south of the Concourse, whilst the remaining accommodation is generally 2-3 storey houses and flats. The main area of open space is known as Heybourne Park (formerly known as Grahame Park Open Space) which is located to the west of the Concourse, whilst other areas of informal open space exist between buildings. Phase 0 and Phase 1A have been completed, whilst Phase 1B, at the southern end of the site, is underway.

ix. The immediate site surroundings are mixed in character. To the north and west of Grahame Park Estate are low-density, predominantly 2-3 storey residential estates, ranging from 1970s to schemes currently under construction or recently completed, as well as the Blessed Dominic School. To the south of the estate are Middlesex University student halls of residence, with blocks ranging between 3 and 4 storeys and the residential development known as Beaufort Park. Immediately to the east of the estate is Colindale Police Station, St James' School and the RAF Museum.

x. A small amount of the regeneration of Grahame Park has taken place already, is under construction, or is committed to by GHA.

xi. Colindale Underground Station, on the Edgware branch of the Northern Line, serves the immediate area and is located some 400m from the southern edge of the estate. The site is well served by the strategic road network, with good access to the A5 to the west and the A41/A1 to the east. The borough boundary with the London Borough of Brent runs along the A5, whilst the M1 and the Thameslink railway form the eastern boundary of the CAAP area.

xii. Grahame Park Estate and its immediate surroundings were developed in the 1960s on the former Hendon Aerodrome, which was one of the earliest aerodromes and aircraft factories in the country and played a key role in the early development of the British aircraft industry and the Royal Air Force. Some buildings from the aerodrome still remain in the area, including the listed former officers' mess and watchtower, whilst the RAF Museum ensures that an aeronautical presence is retained in Colindale.

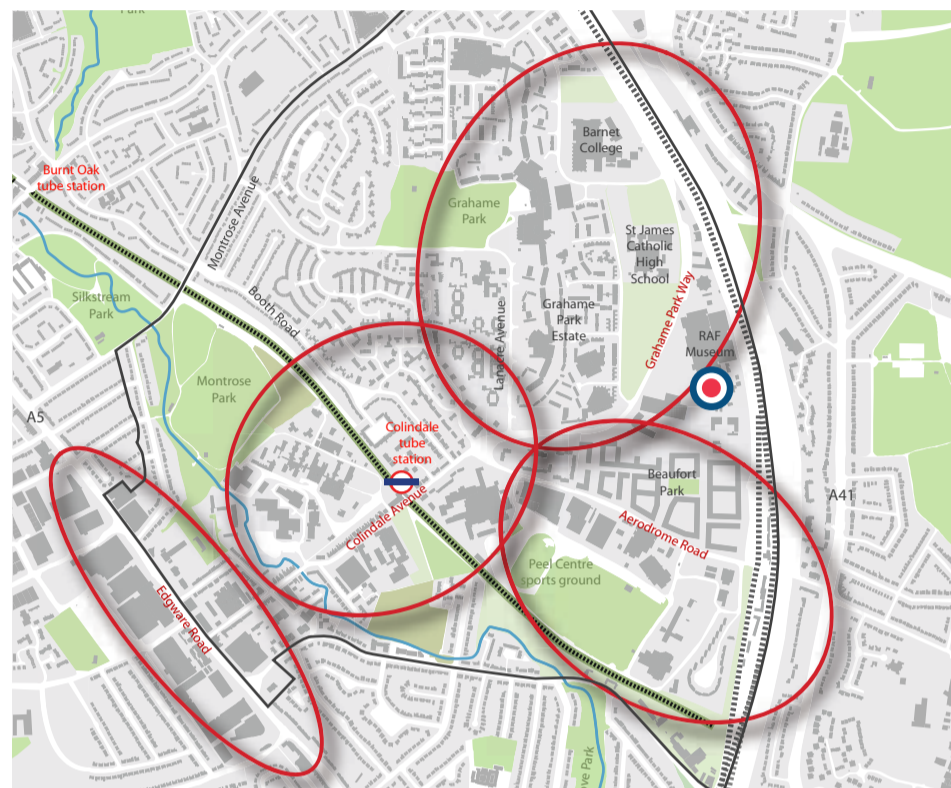

The Corridors of Change

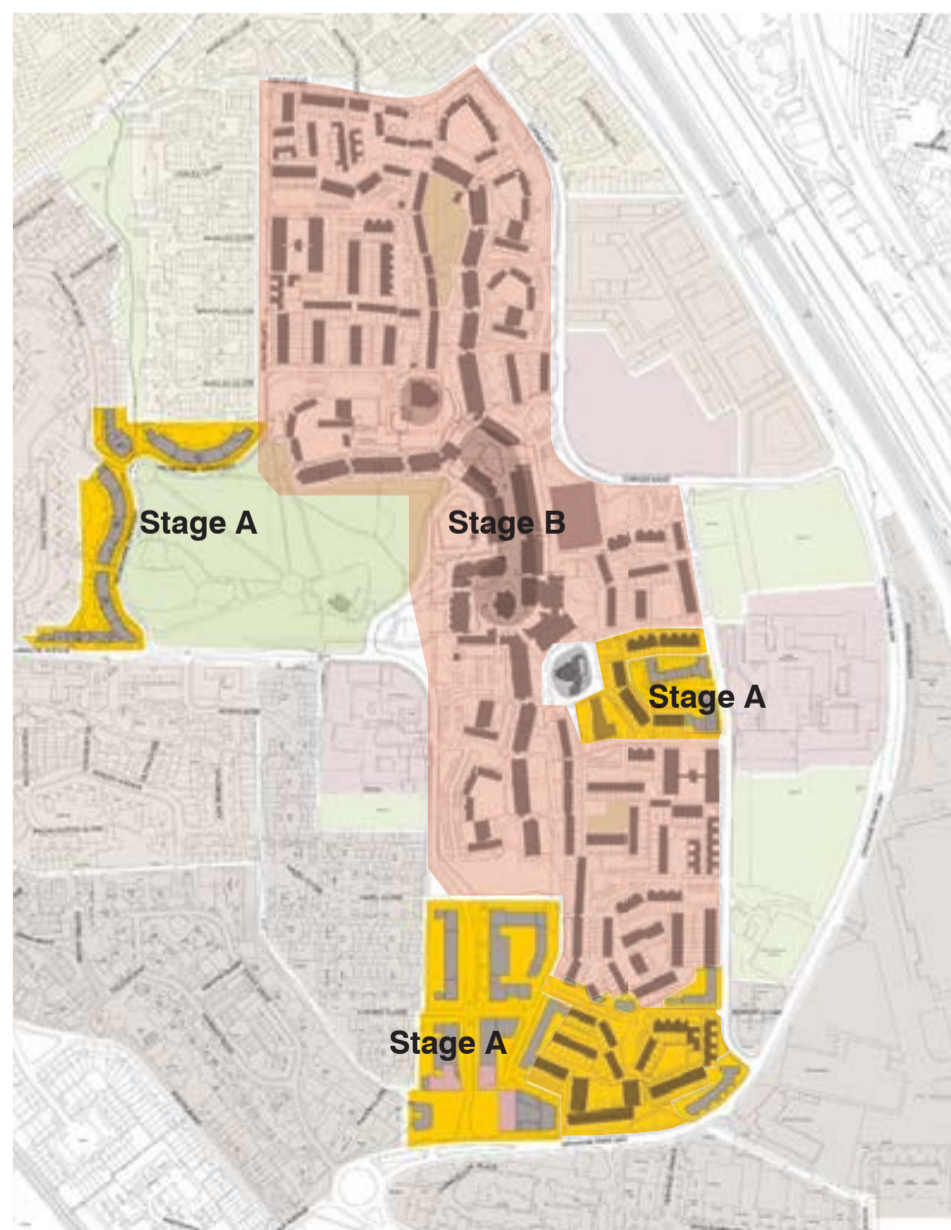

Grahame Park, Stage A and Stage B zones

2.2 THE AREA TODAY

Socio-Economic Profile

- i. The Grahame Park Estate is situated in the Colindale ward, which along with the neighbouring Burnt Oak ward contains LSOAs (lower super output areas) that are within London's 10% most deprived for income, including the LSOAs covering the Estate. Grahame Park also falls within the 10% most deprived LSOAs nationally for employment.
- ii. The ethnic make up of the Colindale ward is mixed, with 12.8% describing themselves as Black African, compared to the Barnet average of 4.3%. The ward also has the highest proportion in Barnet of residents of Chinese ethnic origin. In terms of faith, the ward has the highest proportion of Muslims amongst its residents (19% as compared to 10% for the borough) and the joint lowest proportion of Jewish residents. 63% of school children do not speak English as a first language (compared to 44% for the borough), with Somali, Arabic and Tamil the most common languages.
- iii. The data for school year 2011/12 shows that pupils living in Colindale had the lowest GCSE equivalent point scores per pupil in the borough. The overall rate of claiming for Jobseekers Allowance and benefits is higher than both the borough and national levels. The average life expectancy for males is below the Barnet, London and national levels, whilst the figure for women is slightly lower than for Barnet, but higher than the average for London and England.

Environmental Constraints

- iv. The site or the immediate surroundings are not subject to any statutory designations, but Heybourne Park is designated as a borough level site of local importance for nature conservation (SINC). There are also a range of green spaces within the site, as well as across Colindale that have some ecological value. The nearest Sites of Special Scientific Interest (SSSI) to the site is the Welsh Harp, some 2km to the south.
- v. The park supports three habitats; amenity grassland, scattered trees and ponds. Half of the park, including the ponds, has already been improved as part of Phase 1A. Previous ecology reports have found no evidence of habitats supporting protected species (bats or newts) either on, or within 500m of the site. There is however the potential for nesting birds to occupy trees across the site at certain times of the year.
- vi. The site is not within a designated Flood Zone, although there are parts of the site that occasionally suffer from surface water flooding, due to the age and condition of the existing surface water drainage system.
- vii. The whole of the London Borough of Barnet is an Air Quality Management Area (AQMA). At present, the site is not in a location where air quality management targets are exceeded, although there are some pollution sources close by where targets are exceeded, including along the M1 motorway/A41 to the east of the site.
- viii. The M1 motorway and Thameslink railway line are some 200m from the site boundary and are the main sources of background noise in this part of Colindale. The local road network, including Lanacre Avenue and Grahame Park Way, also result in noise emissions that could affect the future occupiers of any development on the site.

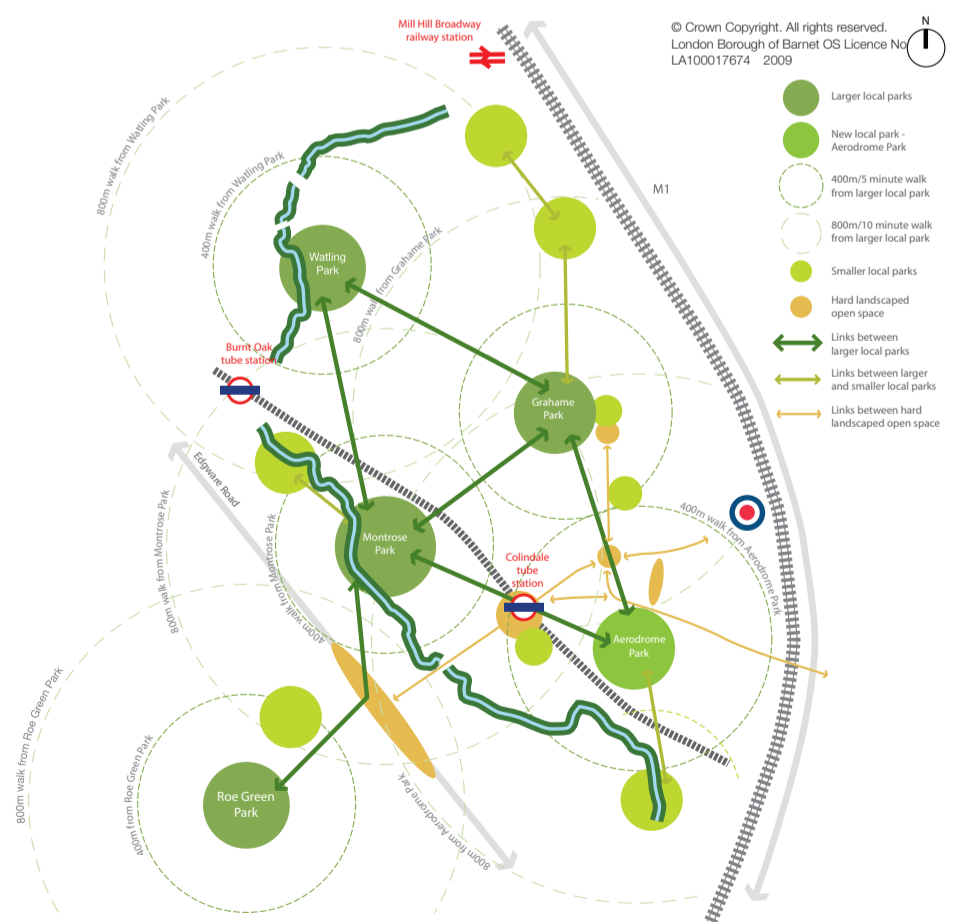

Strategic open space plan for Colindale highlighting the need for a new local park within the eastern side of the AAP area

Built Form and Physical Factors

ix. The original estate was built according to the Radburn principles of separating vehicles and pedestrians. This resulted in a row of apartment blocks of generally 4-6 storeys on a north-south alignment, fronting onto a central pedestrian walkway, with open parking courtyards on the periphery. 2 and 3 storey houses with gardens were located along the north western and south eastern boundaries. A central pedestrianised shopping precinct, known as the Concourse, was created in the centre of the estate, adjacent to the park.

x. The area to the west and north of the site generally comprises low density residential development of 2-3 storeys, with some traditional suburban housing layouts as well as blocks of flats surrounded by gardens. The area to the east of the site is more open in character, including school playing fields and the Barnet and Southgate College campus, although this site has planning permission for residential development of generally 4-5 storeys, with a 9 storey corner feature adjacent to Grahame Park Way. In addition, there are large format buildings to the east of Grahame Park Way, including the RAF Museum and Colindale Police Station.

xi. To the south are a number of sites that have allocations in the CAAP, all of which are expected to be larger in scale than the other suburban areas surrounding Grahame Park. Beaufort Park is a principally residential mixed-use development of apartments of generally between 6-10 storeys, with taller elements. The apartments are arranged in perimeter blocks around communal amenity courtyards, with most of the car parking concealed in undercroft areas. Adjacent to Beaufort Park is the Platt Hall site owned by Middlesex University. This comprises 3 storey halls of residence, as well as a listed 2 storey building that is a remnant of the former airfield use. To the south of both of these sites is the Peel Centre, where an application is currently under consideration for a residential-led mixed use development. The CAAP sets out the Council's aspirations and general guidance for built form across Colindale, with some specific guidance on building heights.

Open Space and Play Space

xii. The estate incorporates a number of open spaces, both public and private. The main area of public open space is Heybourne Park that, following construction of Phase 1A, totals 4.25 hectares. Other more informal areas of public open space are scattered across the site and there are also a substantial number of private gardens associated with the existing houses.

xiii. Across the CAAP area, there are a number of other existing open spaces, including Montrose Park and Colindale Park. In addition, the redevelopment of other sites across the area will result in a series of new parks and open spaces being created. Furthermore, Montrose Park is expected to undergo significant investment, including new sports pitch provision.



Existing layout of Grahame Park showing its Radburn layout



Mixed use supermarket and housing, completed in 2015

Local Shopping and Community Facilities

xiv. The estate currently accommodates a range of retail and community uses, most of which are located within the neighbourhood centre in the Concourse. There are currently 9 Use Class A1 retail units, totalling 1,430sqm of floorspace, including a post office and a pharmacy.

xv. Some new retail floorspace has come forward as part of Phase 1B of the development, including a 420sqm Sainsburys local convenience store and two further retail units of 390sqm and 196sqm. The pharmacy is re-locating to these remaining units. This will be in addition to the future neighbourhood centre that is expected to serve Colindale, which will be located between Grahame Park and the underground station, along Colindale Avenue encompassing sites adjacent to the station, as well as the Peel Centre and the former Platt Hall Middlesex University site to the south of Grahame Park Way.

xvi. The CAAP envisages around 5,000sqm gross of retail space, along with supporting health, leisure and community uses. The new neighbourhood centre is envisaged to serve the existing and new population across Colindale, whilst not impacting on the vitality and viability of other town centres. The CAAP supports the re-provision of the existing neighbourhood centre on Grahame Park, whilst the Barnet Local Plan seeks to ensure that there is no significant reduction of local shopping facilities as a result of development proposals.

xvii. At present, Grahame Park is occupied by a range of existing community facilities, including a community centre, a health centre and adult learning facilities, such as the Flightways Centre.

xviii. In addition, a number of other community facilities have, or are expected to, come forward on other sites across Colindale, including the Former Colindale Hospital site (Pulse), Beaufort Park and the Peel Centre.



Initial consultation held February 2015

Stakeholder Overview

xix. Grahame Park does not have a dedicated residents association or resident-led community action group. However, the local group known as the Colindale Community Trust that runs a group known as Grahame Park Strategy, which brings together local stakeholders to address socio-economic issues affecting the Estate.

xx. Other local stakeholders include:

- the NHS, who operate the health centre;
- Barnet Homes, who are the social housing landlords; and,
- the Churches, who have freehold interests in their sites.

Engagement has been on-going with these stakeholders and further details are set out in the Initial Consultation Report accompanying this draft SPD.

2.3 THE VISION FOR GRAHAME PARK

The Vision

- i. We want the Grahame Park area to become a successful, family-friendly neighbourhood, incorporating the high standards of design, a good mix of uses, and a layout that will meet the needs of current and future generations.
- ii. We want to help achieve an inclusive community made up of existing residents and new residents living together in a safe, accessible environment.
- iii. We want the area to be known for high quality affordable and private homes that address a variety of local needs, including those of the elderly and vulnerable. We also want the area to be known for an outstanding environment with excellent parks and great streets which are accessible to all.
- iv. We want residents to choose to stay in the area because of its quality, such as in its schools and facilities. Overall we want to create a place with a strong sense of community.



A distinctive sense of place

Achieving the vision

We will support the regeneration of our neighbourhood by setting out key principles on the quality of new homes, improved access and transport, great streets, squares, parks and community facilities in the Supplementary Planning Document (SPD).

We will use the guidance established in the SPD to achieve a phased re-development of Grahame Park over the next 15-20 years. The plan will deliver high quality private and affordable homes. There will be a significant proportion of family homes, together with facilities needed by families, to make sure the area is family-friendly.

The new development will retain many of the existing streets but they will be improved to link better with the wider area and provide safe, calm access throughout the area for pedestrians, cyclists, buses and cars. The new homes will overlook the streets and open spaces so there will be much better natural security.

Good urban design and high quality architecture will enable us to provide around 3000 new or refurbished homes, more than at present. Design excellence will be at the core of the redevelopment and we will emphasize and control design quality at each stage of the development to create a varied and interesting new residential neighbourhood.

To reinforce its role as a place for families to live and flourish we will deliver a range of quality public and private open spaces, new local services and opportunities for shopping, employment and training across three new community hubs. The first of these, in Lanacre Avenue is already taking shape.

In this way we will build an exemplary neighbourhood in which current and future residents and their children will want to live and of which we can be justifiably proud.



Safe, overlooked play spaces



Inclusive & accessible public spaces

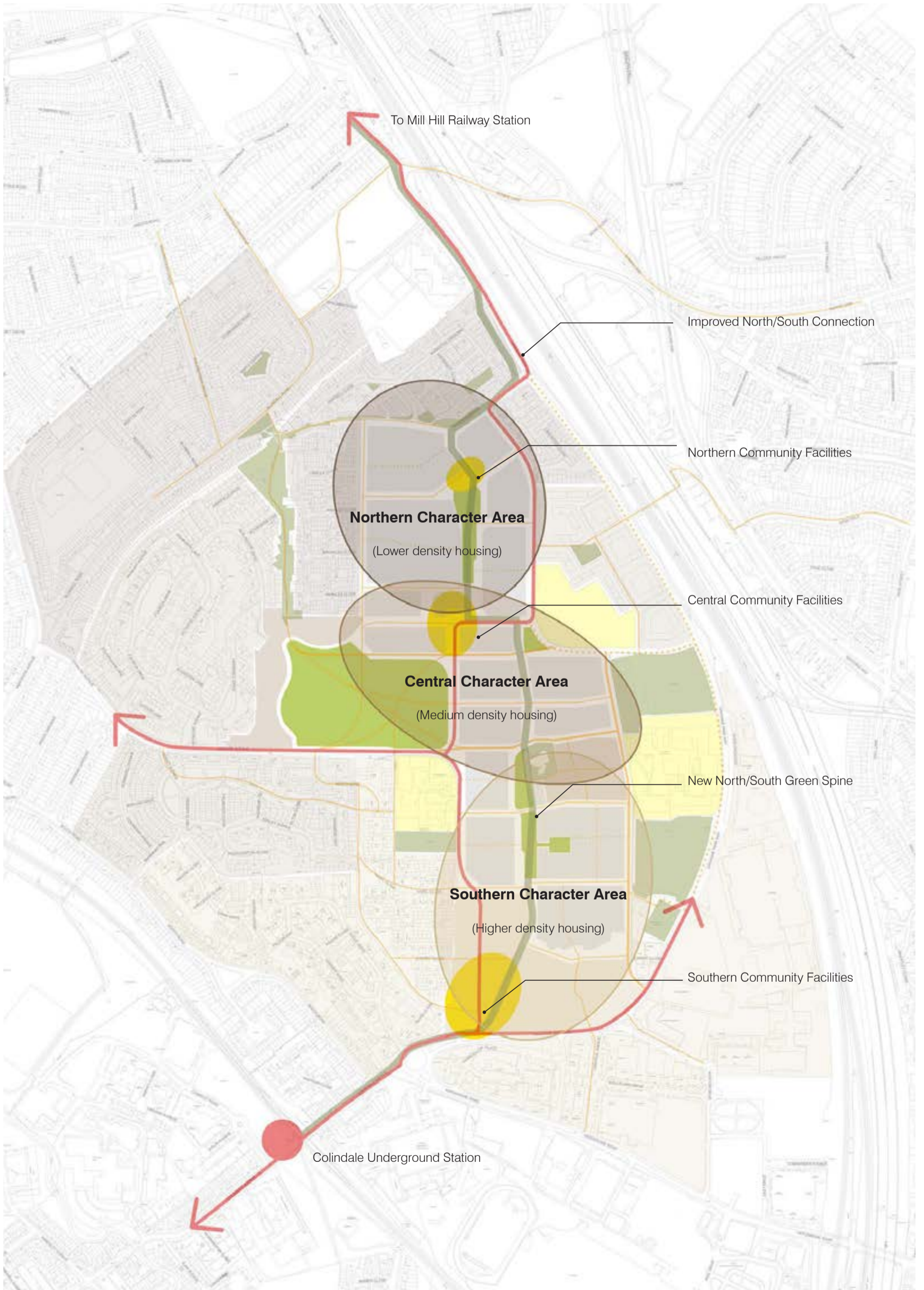

Key Outcomes

v. The new neighbourhood will be constructed around a traditional network of streets, reflecting successful Victorian and Edwardian suburban areas as typical of London streets. The buildings will be low scale, generally no more than 6 storeys with some taller elements to mark key corners, edges and community uses.

vi. New housing should be available in a mixture of tenures, providing some new replacement social rented accommodation, shared ownership and additional social housing where viable, along with enabling private sale housing.

vii. All housing should be built to up-to-date standards in terms of internal space and energy efficiency. There is an opportunity to deliver a large proportion of the new housing as family units, either as maisonettes or as terraced townhouses. This will help with current overcrowding issues on the estate, as well as contributing to a more balanced mix of unit types across the Colindale area.

viii. The regeneration will inevitably improve the quality of the housing stock across the estate, but it is important that features such as cycle storage, amenity space and general storage are designed in from the outset. It will also be important that new housing is fully accessible and adaptable to future needs. Housing should, wherever possible, have front doors to the street and not too many flats to a stairwell core, in order to improve surveillance of the public realm and community cohesion.

ix. The objective is to provide good quality private and communal garden space, whilst ensuring that all properties have good outlook either to the street or to garden areas or open space. Good levels of daylight and sunlight should be achieved, so it will be important that primary windows are not overshadowed. Back to back distances and the design of the housing should ensure that privacy is not compromised.

x. The existing estate is poorly integrated with surrounding neighbourhoods, so it will be important that any new masterplan puts a strong emphasis on improving connections with neighbouring routes, with a particular emphasis on pedestrian, cycle and public transport.

xi. The objective is to create three distinct character areas that connect better with surrounding neighbourhoods. It is important that these character areas relate to their surroundings, both architecturally and in the way that they function. Each character area should have localised centres of activity with shops and community facilities that are accessible to new residents and existing residents of surrounding areas.

xii. It is envisaged that a new network of streets will be created with a clear hierarchy, to ensure that larger roads can accommodate buses, whilst smaller residential streets are narrower and quieter, with reduced traffic speeds. The street network should offer people a choice of routes and should be complimented by features and distinctive buildings that aid navigation. Streets and spaces should not be overly dominated by car parking, but adequate spaces should be provided to serve the development.

xiii. The pedestrian environment within the estate is not user friendly. The aim is to improve some existing well used routes by replacing surface materials and lighting, as well as introducing better natural surveillance from new buildings to reduce anti-social behaviour. New footpaths should be sited close to people's front doors where possible to ensure that they are active and overlooked.

xiv. The existing community facilities are generally concentrated in the Concourse area and, with this area likely to be demolished soon, it will be necessary to ensure continued provision of services through phasing of development or temporary facilities if necessary.



Private rear gardens to family homes



Generous entrance spaces and communal areas



Clearly defined street layouts which are active and overlooked

xv. The objective is to ensure that community and retail facilities are clustered in convenient and accessible locations in each of the character areas. The southern character area already has planning approval as part of Stage A (Phase 1B) for retail and community facilities, including the re-provided library, as well as the re-located Barnet and Southgate College campus.

xvi. The estate has a number of existing green open spaces, including Heybourne Park and areas of public space in between the existing blocks. Many of these spaces have an attractive, wooded quality, with mature trees of amenity value. These spaces should be retained and enhanced, retaining as many trees as possible. Open spaces should be refurbished as development progresses, so that improvements can be realised after each phase of development.

xvii. There are currently a lot of levels changes in the public realm, including underpasses and uneven surfaces. The new neighbourhood should be fully accessible to all and should incorporate surface materials that will stand the test of time.

xviii. It will be important that the new and refurbished open spaces contain activities for all age groups, including play areas for children, outdoor gym and sports facilities for adults and sitting places for the elderly.

xix. In addition, new open spaces should be created as part of new development, including pocket parks, and doorstep play areas. The usability and ecological value, rather than the size or amount of open spaces, will be the important consideration. New tree planting should be maximised, including on streets and in amenity areas.

xx. The Concourse currently blights the rest of the estate and the strategy is to ensure that this is demolished as part of the next phase of development to bring about the change that is needed to add drive to the regeneration.

xxi. The scheme should provide all necessary infrastructure to support the new community, including replacement community and retail facilities, improved public transport, highways enhancement and job brokerage for local people.



Mixed use approach allows for convenient retail and community facilities

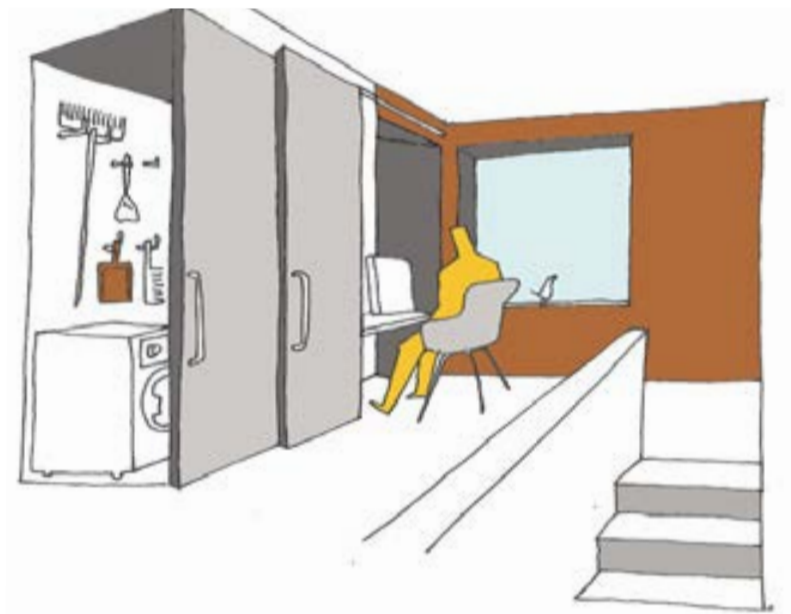

Quality housing that is adaptable and provides good storage

3.0 DEVELOPMENT FRAMEWORK



3.0

DEVELOPMENT FRAMEWORK

To ensure the full regeneration of Grahame Park is delivered to the highest design standards, this Development Framework aims to graphically represent the Vision as set out in this SPD document in Section 2.0.

The Development Framework sets out quantitative principles at a site-wide level through parameter drawings. These parameters act as a foundation for the qualitative principles set within the Design Guidelines, in Section 4.0 of this document.

This document should be read in conjunction with all relevant policies, including the National Planning Policy Framework, Barnet Planning Policies, The London Plan and others.

3.1 CORE DESIGN PRINCIPLES

Creating Better Neighbourhoods

- i. The Neighbourhood Concept Plan (Figure 3.1), presents the approach to the regeneration of the Stage B area of Grahame Park.
- ii. The approach aims to create three Character Areas; the qualities of which relate contextually to the provision of mixed uses, landscape and open space, movement routes, the relationship to the surrounding street network and buildings, heights and densities and building form and articulation.
- iii. The Southern and Northern Areas should define distinctly different urban characters, whilst the Central Character Area pivots between the two, playing an important role to link existing routes, open spaces and facilities in the surrounding area with the growing regeneration and the new central community hub. This approach will be instilled across the estate through comprehensive redevelopment and mixed retention and renewal, to ensure integrated, sustainable, and viable regeneration and urban renewal.
- iv. The Design Guidelines that follow on from this Development Framework section order the Character Areas in this way, ordered from Southern, to Northern and finally to Central, which blends the two.
- v. All plans within this Development Framework are illustrative, and have been developed through a rigorously tested design process. The core principles were presented and supported at public consultation in February 2015. The Statement of Community Involvement can be found in the Initial Consultation Report 2015.

Core Design Principles

- vi. The core design principles which underpin the masterplan approach are:
 - To knit the site into surrounding neighbourhoods by connecting routes, locating convenient community services and enhancing green spaces
 - To remove the concept of the 'estate' by establishing three areas of distinct character in tune with their surroundings, with localised centres and public amenities
 - To improve public facilities with community hubs located across the site to serve the southern, central and northern areas and wider neighbourhoods. See Section 3.2
 - To improve public open space, by enhancing green assets and mature trees, to create useable, attractive, safe and active routes and parks, well positioned for the immediate and wider community. See Section 3.3 and 3.4
 - To improve accessibility with a familiar, legible network of traditional streets and safe, attractive walking routes. See Sections 3.4 and 3.5
 - To develop new quality homes that are well planned, sustainable and adaptable for current and future generations. See Sections 3.6 and 3.7.

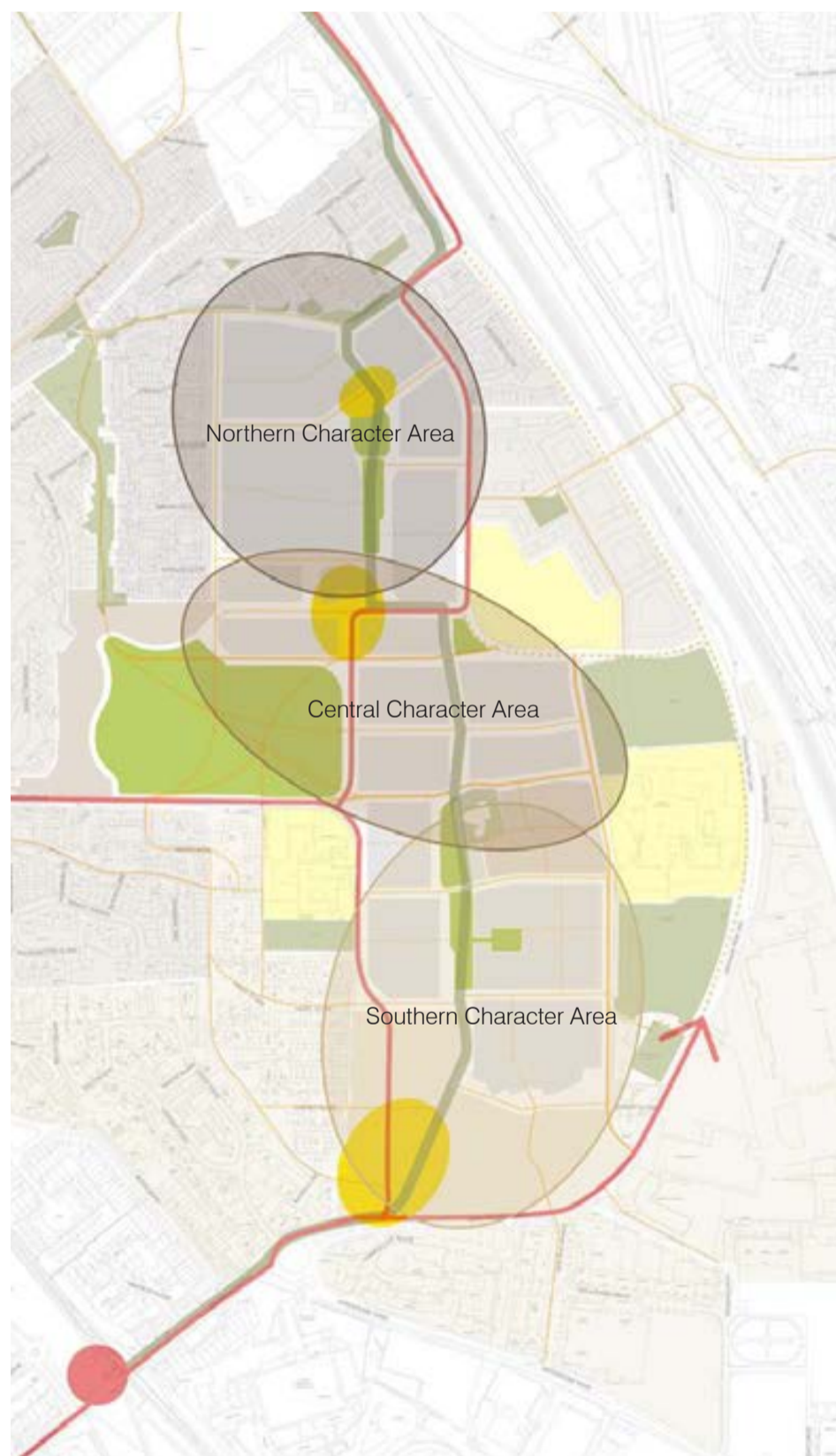

Figure 3.1 - Neighbourhood Concept Plan

3.2 LAND USE MIX

This section sets out the parameters for the siting, amount and types of uses that will be provided across the masterplan.

This is driven by the need to deliver quality residential development as primarily family housing, supported by community facilities and local amenities, located appropriately for the new development and the wider neighbourhoods.

Approach

- i. The predominant use will be residential, but there will be non-residential uses in some areas.
- ii. The land-use parameter plan separates the development into numbered plots and sub-plots. This plan shows the location of the uses and specifies where the different types of non-residential uses will be located.
- iii. For the purposes of this document, comprehensive redevelopment prescribes a full demolition and new build approach to these plots.
- iv. For the purposes of this document, mixed retention and renewal prescribes an infill approach to these plots. This does not prohibit the ability to expand opportunities in the future to include comprehensive redevelopment where appropriate.

Table 3.2 - Use Class Table

Character Area	Sub Plots	Use Class (Maximum Area, GIA m ²)		
		A Retail Uses	D1/D2 Community/ Health Uses	Energy Centre
Central	10 B	500	500 Other D uses eg. Gym	
			1000 Health Centre 800 Children's Centre 500 Community Centre	
Central	10 C	270	1000 Health Centre 800 Children's Centre 2000 Combined Church & Community use	
Central	11 A	500	May share 10B uses	
Central	19A			500*
Northern	16 & 17	500		
Total		1770	3800	500

*Size and location of Energy Centre if relocated to be advised in an Energy Study

Residential Use

- v. This SPD is prepared on the basis of 2161 homes for the area of Stage B. This number is illustrative of the type of quantum to be delivered on site, but should be regarded as indicative as it can be affected by shifts in the housing mix or variations in the assumed density as the design is developed. This figure shall include any existing units that are retained as part of the new development across the areas indicated in Figure 3.2, Land Use Plan.
- vi. Delivery of residential dwellings will need to fall within the range set for habitable rooms, set out as 7442 - 9550 habitable rooms across the framework.
- vii. Numbers of residential units will be provided in each sub-plot in accordance with the density ranges in Section 3.7 Building Heights and Density of the Development Framework.
- viii. Types of residential units will be provided in accordance with the unit type range in Section 3.8 Residential Typologies of the Development Framework.

Non-Residential Use

- ix. Non-residential uses will be provided in accordance with the Land Use plan (Figure 3.2) and the Use Class Table (Table 3.2).
- x. Where the location of some Community Uses is duplicated between plots 10B and 10C in Table 3.2, each use should be allocated to one plot, to a maximum of the quantum allocated for that use.
- xi. Residential provision may be acceptable on Plot 10C where this is needed to support the re-provision of good modern community facilities on the site. Such residential provision should be in keeping with the nature of the community facilities and the surrounding residential context.
- xii. Across the whole of Grahame Park (stages A and B), a minimum of 1,770 sqm of retail uses should be provided. A proportion of this is provided as part of Stage A (as shown on the Land Use Plan, figure 3.2). The remainder will be provided in Stage B in the Central Character Area and Plot 18 as shown. Of the 1770sqm across both A and B, 1430sqm should be predominantly A1 uses, with other A uses also acceptable.
- xiii. Notwithstanding the retail uses permitted, no betting shops /bookmakers shall be provided as part of the development.
- xiv. Outside of Plot 10C, retail uses, followed by community uses, will be prioritised for location on the 'Primary Shopping Frontage', before location in the rest of the areas allocated for Non Residential Uses Stage B, shown on the Land Use Plan, Figure 3.2.
- xv. The location of retail uses will be limited to ground floor space only.
- xvi. Outside of the 'Primary Shopping Frontage' locations, allowance can be given for A Class retail floorspace to be reallocated as flexible residential maisonette units, in response to local need and viability.
- xvii. An explanation of how and when each use will be delivered can be found in the Delivery section of this SPD.

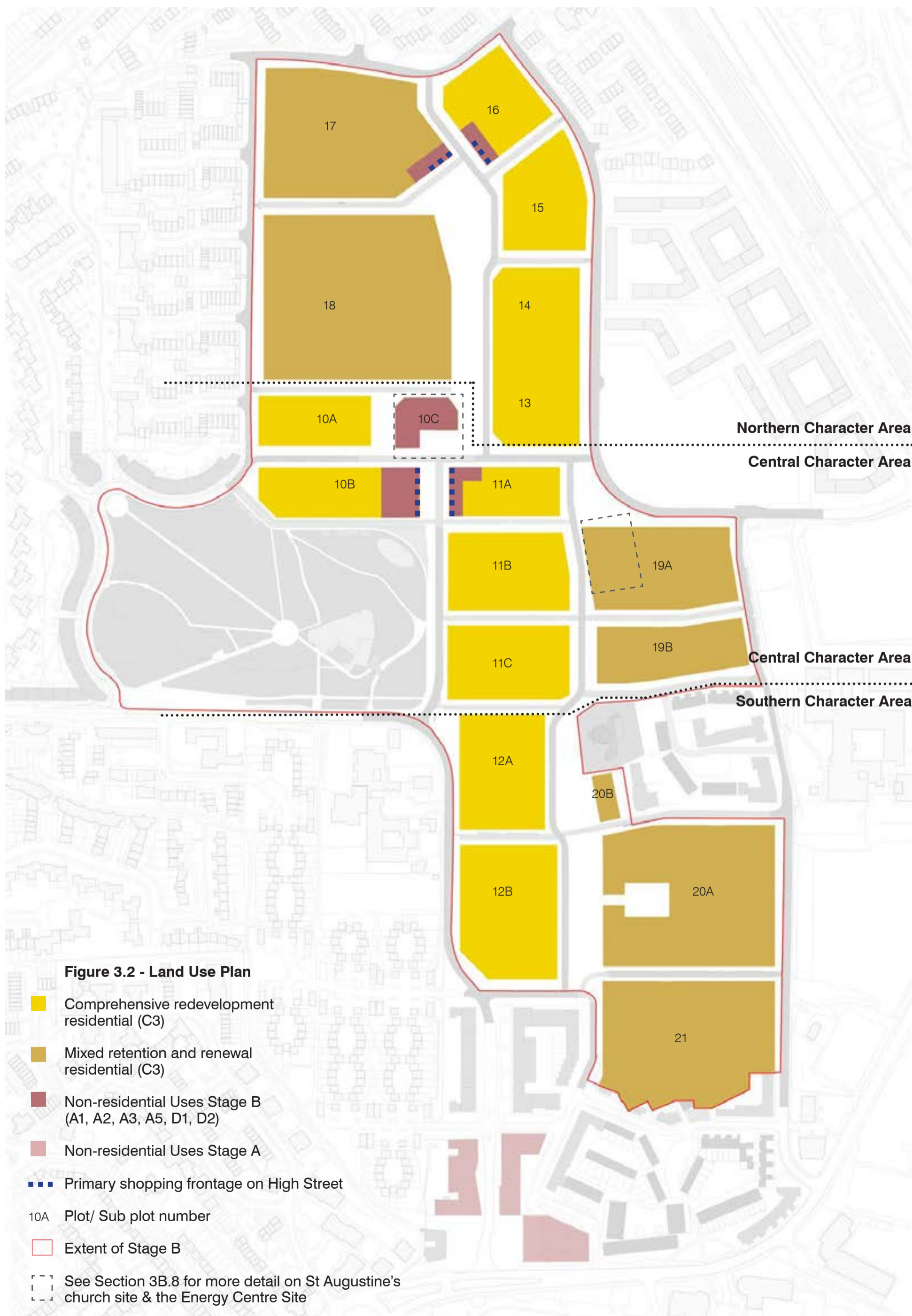

3.3 OPEN SPACES & PLAY PROVISION

This section sets out the parameters for open space and play, in order to create a safe and accessible network of open spaces, integrated with play areas, connected by attractive walking and cycling routes.

These are defined through fixed and unfixed open spaces, based on mature trees and other existing green assets, to ensure the delivery of high quality public amenity space for all residents and neighbours to benefit from.

Table 3.3A - Open Spaces Table

	Plan Ref	Type of Public Open Space	Reference Name	Description
Southern Character Area	S1	Fixed	Southern Woodland Walk	Linear space with mature trees, wild planting, paths and seating
	S2	Fixed	Wooded Park	Established open green space with cluster of mature trees
	S3	Unfixed	Pocket Park	Small open green space with new planting and play space
Central Character Area	C1	Fixed	Neighbourhood Park	Large open space serving wider area, to be improved with new landscape design and outdoor sports facilities
	C2	Fixed	Corner Mead Landscape	Soft and hard contoured landscape with mature trees
	C3	Unfixed	Pocket Park	Small green space defined by clusters of mature trees
	C4	Fixed	Rooftop Play	Sports facility or youth space inhabiting the Energy Centre rooftop*
		Fixed	Public Realm	Large area of high quality public realm as a new public square at St Augustine's Church site*
Northern Character Area	N1	Fixed	Village Green	Useable Open Public Amenity
	N2	Fixed	Northern Woodland Walk	Linear Route with mature trees and wild planting, paths and seating
	N3	Unfixed	Pocket Park	Small green space with new planting
	N4	Unfixed	Pocket Park	Small green space with new planting

Table 3.3B - Locations for Play Provision Table

Age group	Walking distance from all dwellings	Offsite Open Spaces	Fixed Open Spaces	Unfixed Open Spaces	Within Development Plots (communal gardens, residential streets etc)
12+	800m	✓	✓		
5-11	400m		✓	✓	
-5	100m		✓	✓	✓

*Future of the Energy Centre dependent on an Energy Report. See Section 4.10.
*Also see Section 4.9 regarding the redevelopment of St Augustine's Church Site.

Approach

- The Public Open Spaces and Play Provision Parameter Plan (right) specifies where the new or enhanced open spaces and public realm will be provided as part of the development.
- The two tables (below) set out the types of open space and play that will be integrated as part of this approach.

FIXED Public Open Space & FIXED Public Realm

- Fixed public open spaces are areas of accessible public amenity based on the existing green assets, defined by established areas of mature trees and green space. This is the starting point around which the overall concept for Grahame Park has evolved.
- Fixed spaces must be delivered in the locations specified on the plan (Figure 3.3), in accordance with the descriptions set out in Table 3.3A.
- Fixed spaces must also make provision for play spaces as set out in Table 3.3B to enable appropriate accessibility to play from all dwellings.

UNFIXED Public Open Space

- Unfixed spaces are flexible in their location, providing immediate access to public green amenity space and play facilities.
- The location of unfixed spaces needs to respond to required play provision distances, as specified in Table 3.3B to enable appropriate accessibility to play from all dwellings. With the position of unfixed routes through plots (see Section 3.5), this should create a fully accessible network of play spaces across the site.
- In addition, unfixed public open spaces should be located to take advantage of existing green assets within the plot, particularly the value of existing mature tree lines and clusters, as set out in the Tree Strategy in Section 3.4.

Play Provision Approach

- The location of proposed public open spaces in Table 3.3A must ensure walking distances are met for play provision in Table 3.3B.
- Play provision for different age groups is prioritised for different open spaces, both on site and within the surrounding network of existing green spaces, as per Table 3.3B.
- For example, under 5s should be provided for in all local opportunities on site due to the close walking distances, whereas the over 12s can travel further so can be provided for with spaces that are larger and slightly further afield.
- Areas for play need to be provided in line with The London Plan. A link is available in the electronic version of this document at: <http://www.london.gov.uk/priorities/planning/london-plan>.
- The intended type and character of play is set out in the Design Guidelines per character area.
- An explanation of how and when each area of public open space will be delivered can be found in the Delivery Section of this SPD.

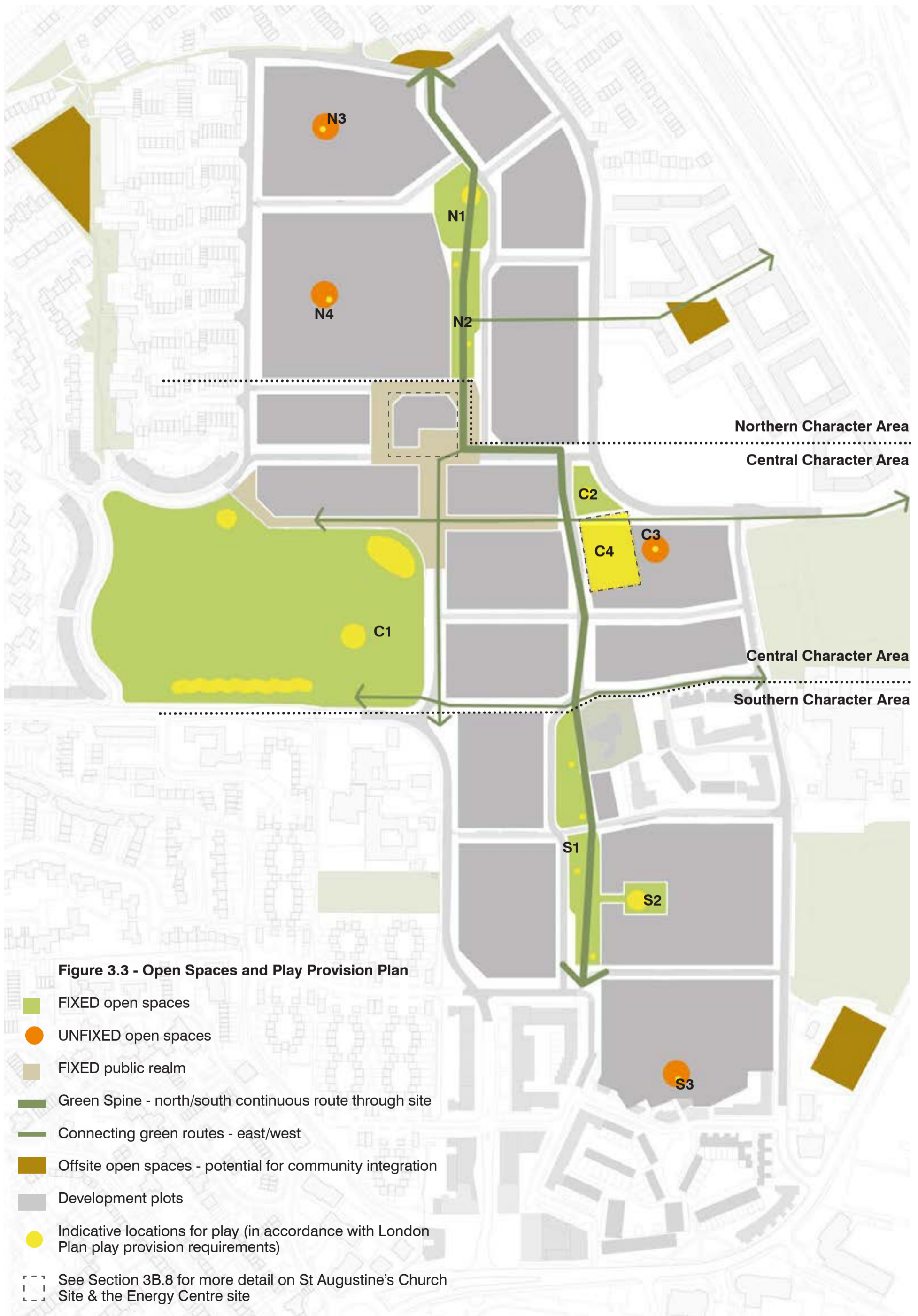

3.4 TREE STRATEGY & REAR GARDEN CONDITIONS

This section sets out the parameters for the retention of the existing quality of mature trees on site.

Enhancing green assets is a core principle, drawing on the existing prevalence of mature tree lines and clusters through the site, to improve public open space and routes.

The conditions for rear spaces have also been set out, differing through the site for the on-plot approach to rear courts and gardens.

Approach

- i. The existing character of large mature trees and existing green spaces has driven the location of fixed public open spaces and the Green Spine. For Open Spaces, see Section 3.3.
- ii. The overarching principle for tree retention and replacement must be to incorporate and protect all existing living and healthy trees.
- iii. Exceptions to the above will only be made if special circumstances are put forward which will benefit the Masterplan and its objectives, outweighing the loss of a tree.

Tree Retention

- iv. The Tree Strategy Plan shows the importance of two categories of existing trees on site in defining the character of the Masterplan:
 - Existing trees on fixed open spaces & the Green Spine
 - Existing trees on-plot & on-street
- v. The retention of existing mature trees, particularly in tree lines and clusters, is desirable as the foundation to creating high quality public and private spaces within the masterplan.
- vi. Existing retained trees on fixed open spaces and the Green Spine should ensure the quality, longevity and integrity of character for each space, in line with the details in the Design Guidelines.
- vii. Existing retained trees on-plot and on-street should ensure the proposed character of the public realm, streets, rear courts and gardens is in line with the details in the Design Guidelines,

Tree Replacement

- viii. Each planning application should be accompanied by a Tree Retention and Replacement Strategy. This Strategy should relate to an arboricultural survey that would also accompany the application and should explain:
 - The number and location of existing trees on the application site;
 - The number and location of existing trees to be removed, along with the arboricultural and/or SPD explanation for each removal; and
 - The number and location of new trees to be planted on the application site.
- ix. It will be expected that the removal of any tree will be replaced within the plot to achieve no loss of greenery or coverage. As a minimum, this could either be achieved on a 'two for one' basis, or one for one if a like for like relocation can be made. This should be detailed as part of each application and this is to be set out in the Tree Retention and Replacement Strategy.
- x. New trees should be located in line with the principles for streets and rear courts & gardens, as set out in the Design Guidelines section of this SPD.

Rear Garden Conditions

- xi. The approach to rear gardens is directly related to the approach for on-plot parking, set out in Section 3.6, and should be read in parallel with Figure 3.6 Car Parking Provision Plan. These are defined by three conditions:
 - Podiums, which use the majority of the rear space in the sub-plot to create a communal garden above a covered parking area beneath
 - Rear courts, which create private raised terraces, projecting a limited distance over the open parking area beneath
 - Private rear gardens, which depict ground-based, private gardens in traditional terraced arrangement.
- xii. The intended character for each of these rear garden types is set out per Character Area in the Design Guidelines section of this SPD.



3.5 STREET HIERARCHY

This section sets out the parameters for the locations and types of streets and routes that will be provided throughout the scheme.

Pedestrians and cyclists are prioritised with the design of accessible, legible and safe routes, linking new streets with existing to knit the development into the surrounding area.

As a key principle, it is envisaged that the Green Spine (see Section 3.3) will be a popular, safe and attractive leisure route through the length of the site. This will allow for separate cycling and pedestrian routes, for walking on pavement and through the Public Green Spaces, and for cycling along the adjacent Avenue.

All road layouts are illustrative and are subject to traffic modelling, to be used to support future planning applications.







Figure 3.5A
Pedestrian Priority Routes



Figure 3.5B
Bus Route Strategy

Table 3.5 - Street Hierarchy Table

Hierarchy	Typology	Fixed / Unfixed
 Primary Routes (Boundaries and Bus Route)	2m pavements (or 3.1m for location of bus stops or outside of schools) either side of 7.3m wide carriageway, accommodating bus route and with cycling integration	Fixed
 Secondary Routes (Boundaries and the Avenue)	2m pavements either side of 5.5m wide carriageway with integration for cycling.	Fixed
 Tertiary Routes (The Lanes)	2m pavements either side of 5.5m wide carriageway with integration for cycling.	Fixed
 Residential Streets (Types A & B)	Type A: 2m pavements either side of 4.5m wide carriageway through plots. Type B: Shared surfaces incorporating parking, planting and local play provision. Both prioritise the integration and accessibility of cyclists and pedestrians in these spaces	Fixed and Unfixed

Approach

- The Street Hierarchy Plan identifies the network of streets that will form the layout of the new neighbourhood. A description for each is given in Table 3.5.
- The approach establishes a network of FIXED routes between plots that create a safe, accessible and legible street pattern, knitting the site into the surrounding area. UNFIXED streets subdivide the plots further to encourage movement and permeability as more local, residential connections.
- The balanced integration of pedestrians, cyclists and vehicles along safe and attractive routes is a priority, in order to create defined streets that are active, legible, overlooked and visually open. This is in contrast to the current condition, which separates vehicle and pedestrian routes, to the detriment of each plot (see Figures 3.5A & B).
- The plan allows for a bus route to pass along a central route connecting to existing bus routes in the north and south of the SPD area. This is currently expected to be the 303 bus route (see Figure 3.5B).
- All routes are to allow for cycle integration with other vehicles, as per Manual for Streets 1 & 2 and TFL LCDS guidance. Faster cyclists are likely to use the Primary Routes, as is the norm for the Stage A development and the wider area, and the Avenue expected to be slower moving and quieter, for more leisurely cycling along the Green Spine, and adjacent to green spaces.
- Consideration should be given for crossovers and junctions, particularly with primary routes. All streets are to be fully accessible with dropped or flush kerbs, footways and crossings.
- The Primary Route which includes the Bus Route will be adopted. Adoptability of other roads will be considered at the time of each planning application and in light of current policies at the time of applications. All adopted streets will be designed to conform with LBB standards.

FIXED Routes

- FIXED routes can only be provided in the locations shown on Parameter Plan, Figure 3.5C. The detailed character of the FIXED street typologies is set out in the Design Guidelines section per Character Area.

UNFIXED Routes

- The UNFIXED Routes located on the Street Hierarchy Plan, Figure 3.5C show where movement routes must be provided through plots. These routes are essential to increase permeability and accessibility, and ensure the development is well integrated into the surrounding neighbourhood.
- The locations of UNFIXED Routes shown on the Street Hierarchy Plan, Figure 3.5C are flexible. They should be as linear as possible and respond to other masterplan objectives set out in this document, relevant to both Mixed Retention and Renewal and Comprehensive Redevelopment approaches (see Section 3.2).
- UNFIXED Routes provide important accessibility to play, particularly for dwellings nearer the periphery of the site. Their layout should be considered in conjunction with walking distances to play provision, set out in Section 3.3.
- UNFIXED Routes employ only the Residential Streets Type A and B. Their detailed character is set out in the Design Guidelines section per Character Area.
- If plots are to be further subdivided beyond the routes shown on the Street Hierarchy Plan (Figure 3.5C), only Residential Streets Type A and B can be used.

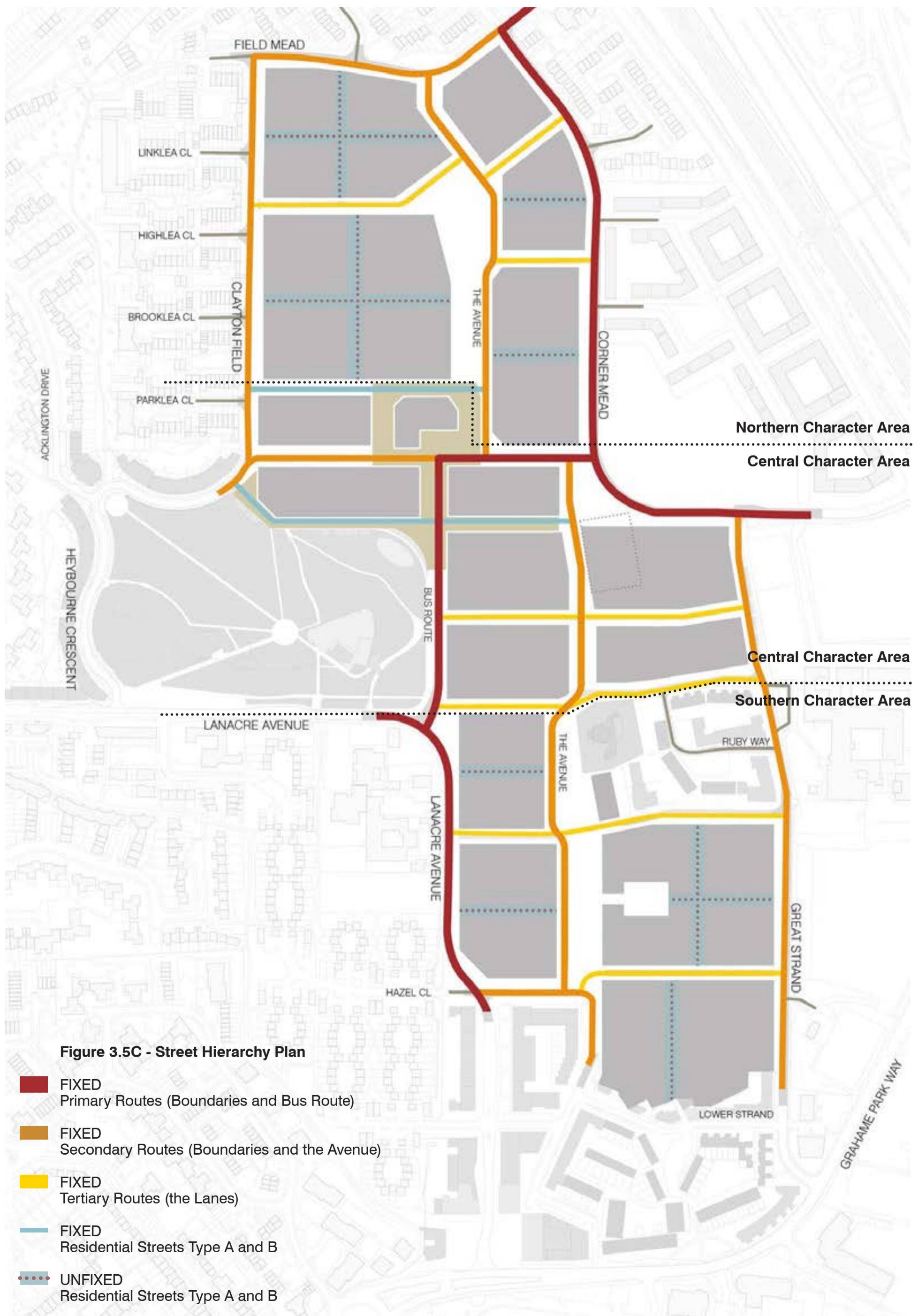

Figure 3.5C - Street Hierarchy Plan

- FIXED**
Primary Routes (Boundaries and Bus Route)
- FIXED**
Secondary Routes (Boundaries and the Avenue)
- FIXED**
Tertiary Routes (the Lanes)
- FIXED**
Residential Streets Type A and B
- UNFIXED**
Residential Streets Type A and B

3.6 CAR PARKING

This section sets out the parameters for the quantum and types of car parking that will be provided across the scheme.

The preference is for on-street car parking to be exercised across the whole site. on-plot parking is expected to be more prevalent in the south with higher densities and mansion block typologies, and minimal in the north with lower densities and more traditional streets, gardens and housing typologies.

Approach

- The Car Parking Provision Plan (Figure 3.6) specifies the approach to car parking and where different parking typologies will be acceptable.
- On-street parking should reflect typical London streets, with some parking provided in clusters on green edges (at the edge of open spaces) and on some boundary routes, as specified on the Car Parking Provision Plan, Figure 3.6. This approach should be read in conjunction with the Street Hierarchy Plan, Section 3.5, and the street details within the Design Guidelines.
- On-plot parking should correlate with the approaches for rear garden conditions, building heights and densities and residential typologies. These are set out respectively in Sections 3.4, 3.7 and 3.8 of this Development Framework, and detailed per Character Area within the Design Guidelines.
- Cycle parking will be provided at key destinations such as public open spaces and at the Neighbourhood hubs, integrated into the public realm in convenient and accessible locations, as per the CAAP.

Table 3.6 - Parking Ratio Table

Character Area	Indicative Ratio	On-Street Approach	On-Plot Approach
Southern Character Area	0.7	<ul style="list-style-type: none"> Parking acceptable on all streets Bay parking acceptable on: <ul style="list-style-type: none"> Green Edges Residential Streets Type B 	<ul style="list-style-type: none"> Acceptable in a mix of: <ul style="list-style-type: none"> Podiums Rear Courts
Central Character Area	0.9	<ul style="list-style-type: none"> Parking acceptable on all streets Bay parking acceptable on: <ul style="list-style-type: none"> Green Edges Residential Streets Types A and B 	<ul style="list-style-type: none"> Acceptable in a mix of: <ul style="list-style-type: none"> Podiums Rear Courts
Northern Character Area	1.2	<ul style="list-style-type: none"> Parking acceptable on all streets Bay parking acceptable on: <ul style="list-style-type: none"> Green Edges Residential Street Type B Some Boundaries 	<ul style="list-style-type: none"> Acceptable in a mix of: <ul style="list-style-type: none"> Rear Courts (minimal, adjacent to Avenue only) Garage parking (minimal - only on Residential Street Type B. See restrictions)

Ratios

- Table 3.6 sets out the indicative parking ratios for each of the Character Areas. These ratios should be commensurate with the Public Transport Accessibility Level (PTAL) of each area. The current PTAL ratings (2015) are 2-3 in the Southern Character Area, 2 in the Central Character Area and 1-2 in the North.
- Parking provision for the development as a whole and the design of road networks will meet the Council's Policy DM17 Travel Impact and Parking Standards of the LB Barnet Development Management Document. It should include other forms of parking, such as for, electric cars, disabled access, car club use and other requirements in accordance with parking policy.
- Parking on-street is to be un-allocated and to allow residents to access car parking within a distance of the adjacent plot.
- Consideration should be given to the provision of car club bays, depending on demand from operators

Type

- It is expected that a Controlled Parking Zone (CPZ) will be exercised on publicly managed roads.
- Podium parking allows for cars to be located beneath a communal garden level, accessed by the associated residents only, with integrated bin storage. Lightwells and planting link between the two levels.
- Rear court parking consists of a resident-only shared space for parking, with raised private gardens projecting from the dwellings above. The parking is generally open and overlooked, with attractive surfacing and planting.

- Private rear gardens indicates units which would have minimal to no on-plot parking. In the case of the Northern Character Area, single garages integrated within single family dwellings would be acceptable on Residential Street Type B only. These dwellings would comprise a maximum of 50% of the units on the street, to ensure the majority of the street retains active dwelling frontages.

Mixed Retention and Renewal

- The character and quality of these conditions is set out per Character Area in the Design Guidelines.
- The quantitative provision of parking for both comprehensive redevelopment and mixed retention and renewal needs to be measured in relation to relevant planning policy at the time of submitting proposals.
- The intended approach for parking within each Character Area as set out in the Development Framework and Design Guidelines should be taken forward in mixed retention and renewal development as far as possible.
- It is proposed that mixed retention and renewal development should achieve the prevailing parking ratio designated for the character area in which the site is situated. This approach can be subject to a detailed survey within the design process which will identify any special circumstances which may affect this approach.



Northern Character Area
 Central Character Area

Central Character Area
 Southern Character Area

Figure 3.6 - Car Parking Provision Plan

- On street parking
- Bay parking along green edges
- Bay parking along boundaries
- Parking as per FIXED Residential streets Type A and B
- ⋯ Parking as per UNFIXED Residential streets Type A and B
- On-plot parking condition - predominantly podiums & rear courts.
- On-plot parking condition - predominantly rear courts & private rear gardens.
- On-plot parking condition - minimal on-plot parking. Predominantly private rear gardens.

3.7 BUILDING HEIGHTS & DENSITY

This section sets out the parameters for building heights and density. The approach aims to ensure new development is in keeping with surrounding areas as far as possible.

As a principle, the scale and density of buildings reduce from south to north, in line with the proposed character areas and the neighbouring context.

Approach

- i. The Heights and Massing Plan (Figure 3.7B) specifies the typical height of buildings for each plot, as well as locations for feature buildings.
- ii. The massing approach is sensitive to new and existing neighbouring context by graduating from the highest development in the south to the lowest in the north. Through the site, feature buildings, named 'key frontages' and 'prominent corners' provide landmarks and way-finding devices and frame public spaces.
- iii. Heights for each area have been set out in Table 3.7. In areas of mixed retention and renewal (see Land Use Plan, Figure 3.2), development needs to respond more sensitively to immediate buildings, therefore density and heights of typical blocks and prominent corners have been set out accordingly.

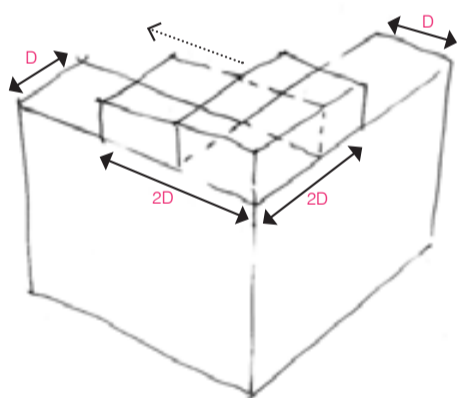

Figure 3.7A - Example of Prominent Corners and Nodes, see paragraph xiii.

Table 3.7 - Height & Density Ranges

Comprehensive Redevelopment	Density Range (U/ha)	Minimum Height (storeys)	Maximum Height (storeys)	Prominent Corners maximum height (storeys)
Southern Character Area	130-160	4	6	8
Central Character Area	100-130	3	6	8
Northern Character Area	50-100	2	4	5

Mixed Retention and Renewal	Density Range (U/ha)	Minimum Height (storeys)	Maximum Height (storeys)	Prominent Corners maximum height (storeys)
Southern Character Area	130-160	2	5	6
Central Character Area	100-130	2	5	6
Northern Character Area	50-100	2	4	5

Density

- iv. Density will be calculated in accordance with guidance set out in the London Plan and Mayor's Housing SPD, on a net site area basis for each Character Area on assessment of each planning application. Calculation methodology for mixed use development will apply on applications that incorporate non-residential uses.
- v. Densities will be expected to lie within the ranges set out in Table 3.7, but proposals must also comply with the other requirements of this SPD, so it will not necessarily be appropriate for all proposals to be at the top end of the ranges.

Building Heights

- vi. Residential storey heights shall be a maximum of 3.5m and non-residential 4.5m (floor to floor), subject to requirements of land-uses.
- vii. Typical block heights should always be proportional to the width of streets as set out in each of the street sections in the Design Guidelines. It will not necessarily be acceptable to maximise heights in all areas.

Key Frontages

- viii. Key frontages are classified as the buildings that front onto the main fixed open spaces, located in fixed positions on plots, as per Figure 3.7.
- ix. These buildings should utilise the maximum height afforded to them per character area, intended to establish a hierarchy of buildings within their locality as the most prominent buildings of the plot.
- x. These buildings have an important role to play in framing large public spaces and overlooking active movement routes through the site. As 'foreground' buildings, their facades should be more open, proud and animated, in tune with the character of the public open spaces and respond to views from both close and afar.

Prominent Corners and Nodes

- xi. Prominent Corners and Nodes are classified as positive built moments, located strategically, adjacent to fixed open spaces and on long view lines. Their positions are suggested, as per Figure 3.7B, but does not preclude other locations.
- xii. Building heights for the prominent corners can extend above the maximum height parameters, as set by the Heights and Density Range Tables.
- xiii. To ensure prominent corners and nodes are maintained as a 'point height' and do not extend along the full building frontage, this additional height is permissible along the building's frontage, to an approximate distance of 2x the depth of the building, typically in just one direction. See Figure 3.7A.
- xiv. These height freedoms are to encourage flexibility and diversity in design for these unique locations. It will not be acceptable to provide the maximum height as specified for every location.
- xv. Where prominent corners and nodes are shown within the Energy Centre and St Augustine's Church sites, these are not expected to provide residential accommodation, but allow for a singular point of substantial height as, for example, a chimney or church spire respectively.

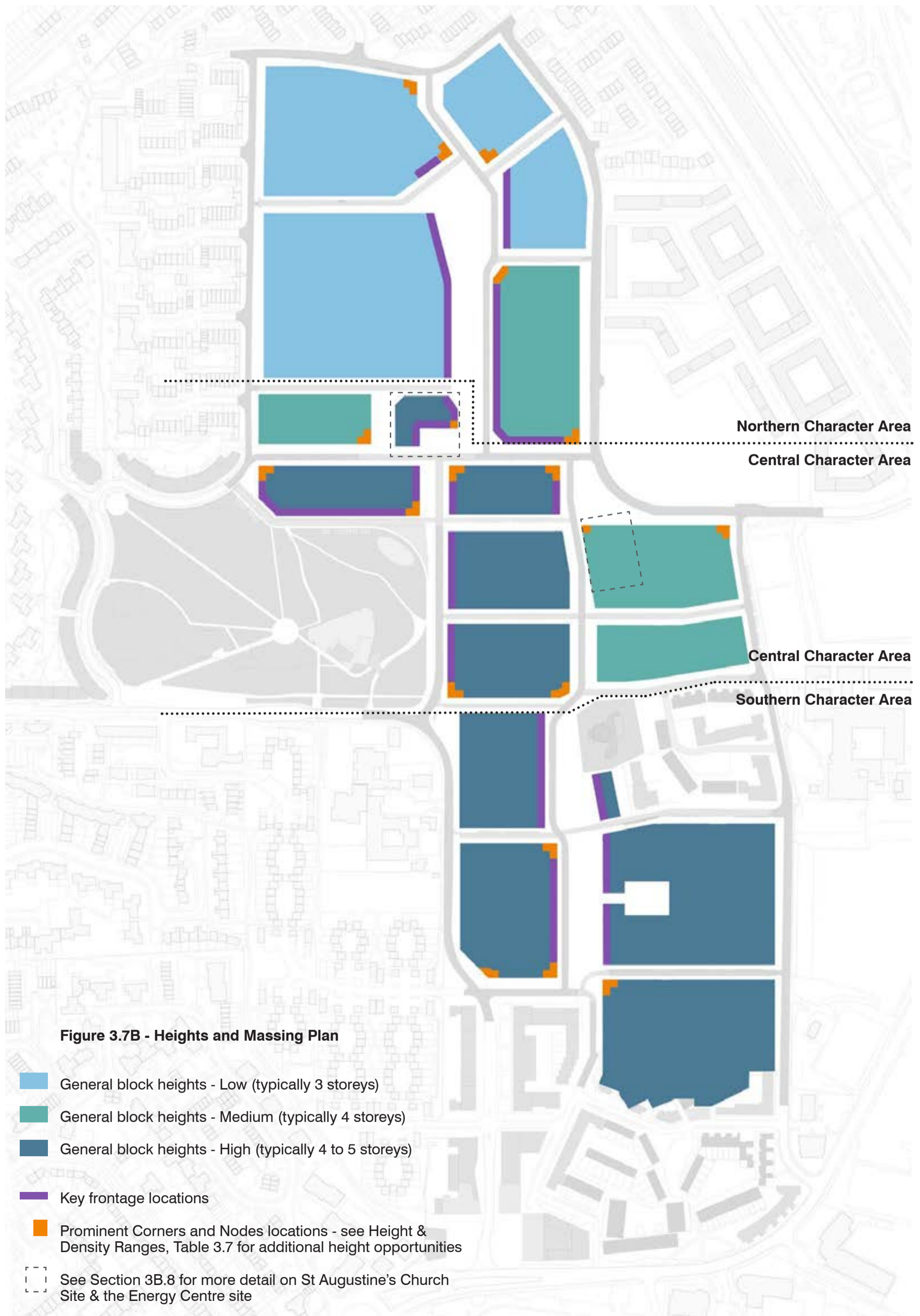

3.8 RESIDENTIAL TYPOLOGIES

This section sets out the parameters for residential building typologies, reflective of the three Character Areas and their relative densities, with an emphasis on family housing.

In line with the Heights and Density Parameters (see Section 3.7), the building typologies graduate from mansion blocks in the South, to more traditional terraced housing in the north. The central portion of the site presents a combination of the two, defined by contextual relationships to public open spaces, the community hub, nearby schools and adjacent developments.

Approach

- i. The Masterplan sets out to deliver a high level of family sized housing. The quantum for the mix of dwelling sizes is set out in Table 3.8 for unit mix.
- ii. The provision of these dwelling types within the masterplan is defined by three typologies: mansion blocks, terraced housing and mixed typologies.
- iii. The Residential Parameter Plan Figure 3.8 explains where these would be prioritised across the scheme. Details of the character of the housing typologies can be found in the Design Guidelines section.

Mixed Retention and Renewal

- iv. Mixed retention and renewal development should ensure careful consideration is given for neighbouring and retained buildings.
- v. The intended urban grain of each Character Area as set out in the Design Guidelines should be taken forward in mixed retention and renewal development as far as possible.
- vi. Mixed retention and renewal development should in particular ensure the edges and corners of plots express the proposed built character and residential typology set out for each Character Area.

Unit Mix

- vii. The Unit Mix Table (Table 3.8) sets out the mix of units that would be expected to come forward per plot in each Character Area.
- viii. Applications will be assessed against the ranges set out in Table 3.8, alongside current policy, and the dwelling mix will be expected to fall within these ranges.

Table 3.8 - Unit Mix Table

	1 beds	2 beds	3 & 4 beds
Southern Area (High Density)	15-30%	20-40%	30-50%
Central Area (Medium/Mixed Density)	10-25%	20-40%	40-65%
Northern Area (Low Density)	0-20%	15-30%	50-80%

Mansion Block Typologies

- ix. Mansion block typologies predominantly consist of stacked maisonettes, with flats at upper levels. These are the tallest and densest blocks in the masterplan, relating more to central Colindale. For corresponding heights and densities per Character Area, see Section 3.7 of the Development Framework.
- x. Block typologies are compatible with podium and rear court parking. These types should be read in conjunction with Sections 3.4 and 3.6 of this Development Framework, for rear garden conditions and car parking respectively.
- xi. Development at the corners of plots are defined with strong built form. This is particularly prevalent in the Southern Character Area as characterised in the Design Guidelines.

Terraced House Typologies

- xii. Terraced house typologies are the lowest rise and lowest density blocks, consisting predominantly of single family houses with traditional private ground-based rear gardens. These types should be read in conjunction with Sections 3.4, 3.6 and 3.7 of this Development Framework, for rear garden conditions, car parking and building heights & densities respectively.
- xiii. Development at the corners of plots should be presented with gable ends. Necessary breaks in the built line, expressed with strong garden walls, should celebrate the pattern of traditional terraced housing and rear gardens. This intended built character is set out in the Design Guidelines section of this SPD.

Mixed Typologies

- xiv. Mixed typologies enable a combination of flats above single or stacked maisonettes, and single family terraced houses, to create a blend of architectural massing and type that are set out for the Southern and Northern Character Areas.
- xv. Mixed typologies suit a combination of rear court parking with raised gardens, and traditional ground-based rear gardens.
- xvi. These types should be read in conjunction with Sections 3.4, 3.6 and 3.7 of this Development Framework, for rear garden conditions, car parking and building heights & densities respectively.

Continuous Plot Frontage

- xvii. The locations of continuous plot frontage show where built form should present a continuous street facade where possible for each plot edge, preferring not to be broken by garden walls or gable elevations.
- xviii. These are mainly located on the boundary streets, to give a consistent and defined street frontage elevation, clearly ordering, overlooking and animating the outer edges of the site. This approach intends to knit new development into the existing neighbourhood, interacting with surrounding development in an open, positive and sensitive manner.
- xix. Punctuations through the continuous plot frontage from the location of UNFIXED streets are appropriate as either a full break in the building line, or as two storey cut-throughs. The character of these building lines and appropriate punctuations are detailed by Character Area in the Design Guidelines.

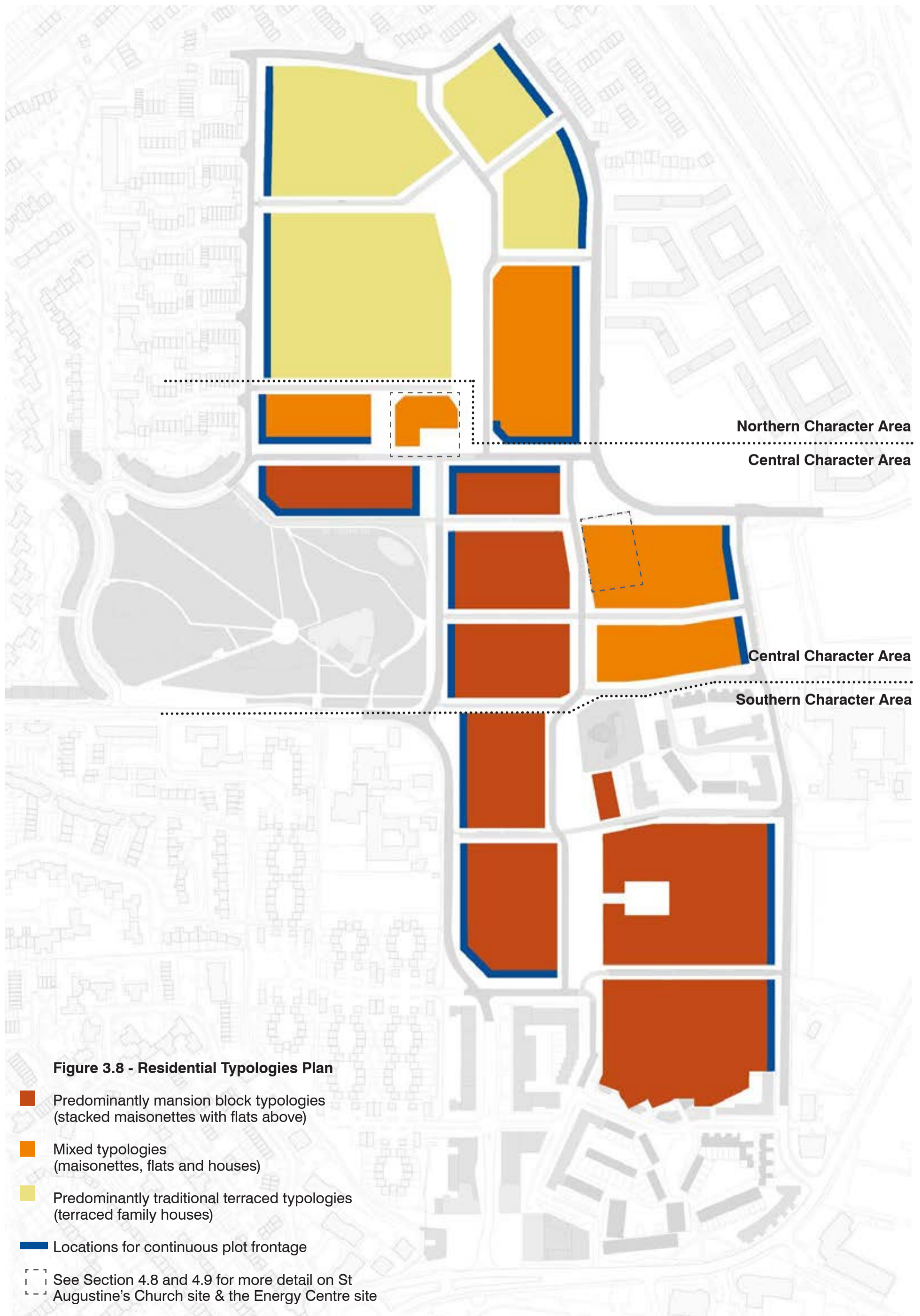

Figure 3.8 - Residential Typologies Plan

- Predominantly mansion block typologies (stacked maisonettes with flats above)
- Mixed typologies (maisonettes, flats and houses)
- Predominantly traditional terraced typologies (terraced family houses)
- Locations for continuous plot frontage

--- See Section 4.8 and 4.9 for more detail on St Augustine's Church site & the Energy Centre site

